

SURGING

紹 鑫 實 業



SurgeArresters

陶瓷气体放电管

SMA Series

Features

- Small Size Design 2.9×2.1×1.9mm
- Current Handling Capability 1,000A @ 8/20us
- Low Capacitance and Insertion Loss
- Fast Response and Long Service Life
- Reliable to Protect Electrostatic Surge
- Moisture sensitivity level: Level 1

Exterior

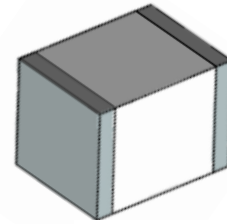

SMD

Application information

- RS485/232/422
- Internet

Package (Top View)

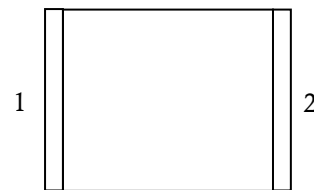

Agency Approvals

Icon	Description
RoHS	Compliance with 2011/65/EU
HF	Compliance with IEC61249-2-21:2003
	Mean lead free

Schematic Symbol

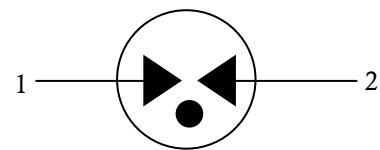

Electrical Parameter

DC Breakdown Voltage 1)2)	100V/s	63-117	V
Impulse Spark-over Voltage	At 1kV/μs	for 99 % of measured values	≤ 650 V
	At 1kV/μs	Typical values of distribution	≤600 V
Impulse Discharge Current 3)	8/20μs, ±5Times	1,000	A
Impulse Discharge Voltage 3)	10/700μs, ±5Times	6,000	V
Arc Voltage	At 1A	~10	V
Insulation Resistance	DC=50V	≥1	GΩ
Capacitance at 1 MHz	VDC=0.5V	≤0.5	pF
Weight		~0.062	g
Operating And Storage Temperature		-40-125	°C
Marking		Without	

1) At delivery AQL 0.65 level II ISO 2859

2) In ionized mode

3) Terms and waveforms in accordance with ITU-T Rec. K. 12; IEC 61643-21

Part Numbering System

SMA 90 XN
 (1) (2) (3)

- (1) SURGING Gas Discharge Tube
- (2) Series: DC Breakdown Voltage, e.g.: 90 = 90 V
- (3) Tolerance of DC Breakdown Voltage, XM = $\pm 20\%$
 XN = $\pm 30\%$

Product Characteristics

Lead Material	Copper or iron nickel alloy
Body Material	Ceramics
Terminal Finish	100% Matte-Tin Plated

Environmental Reliability Characteristics

Testing items	Technical standards
High Temperature Storage Test	Temperature: 125°C Time: 2H
Low Temperature Storage Test	Temperature: -40°C Time: 2H
Vibration	Frequency: 10-500Hz Amplitude: 0.15mm Time: 45mins
Resistance of soldering heat	Temperature: 260 \pm 5°C Time of dip soldering: 10s, 1time

Note: Up-screen program can be specified by customer's request via contacting SURGING service

Solderability test

Solderability	Solder Pot Temperature:	245°C \pm 5°C
	Solder Dwell Time:	4-6 seconds

Product Dimensions

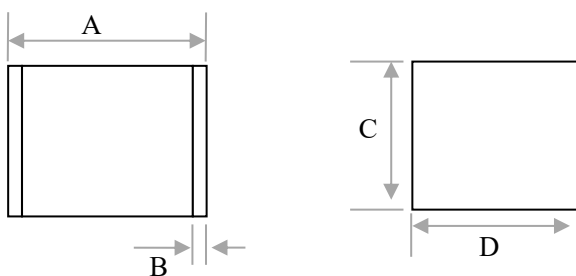

REF	mm	inch
A	2.9 \pm 0.2	0.114 \pm 0.008
B	0.3 \pm 0.1	0.011 \pm 0.004
C	1.9 \pm 0.1	0.075 \pm 0.004
D	2.1 \pm 0.2	0.084 \pm 0.008

Recommended Soldering Pad

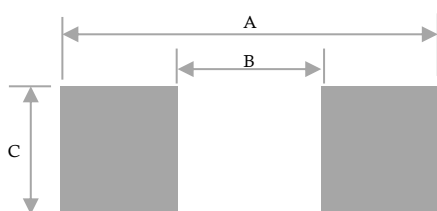

REF	mm	inch
A	3.5	0.138
B	2.1	0.083
C	2.3	0.091

Reflow Profile

Reflow Condition		Pb-Free assembly
Pre Heat	Temperature Min	150°C
	Temperature Max	200°C
	Time (min to max)	60 – 180 secs
Average ramp up rate (Liquids) Tmp (TL) to peak		3°C/second max
Ts(max) to TL - Ramp-up Rate		3°C/second max
Reflow	- Temperature (TL) (Liquids)	217°C
	- Temperature (TL)	60 – 150 seconds
Peak Temperature (Tp)		260+0/-5 °C
Time within 5°C of actual peak Temperature (tp)		8 – 20 seconds
Ramp-down Rate		6°C/second max
Time 25°C to peak Temperature (Tp)		8 minutes Max.
Do not exceed		260°C

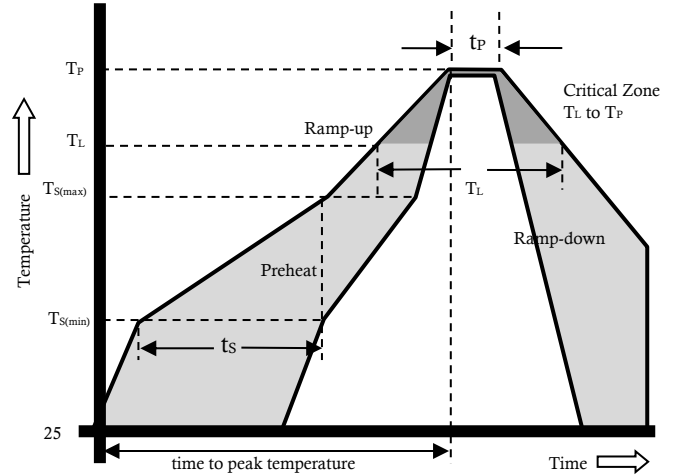

Package Reel Information

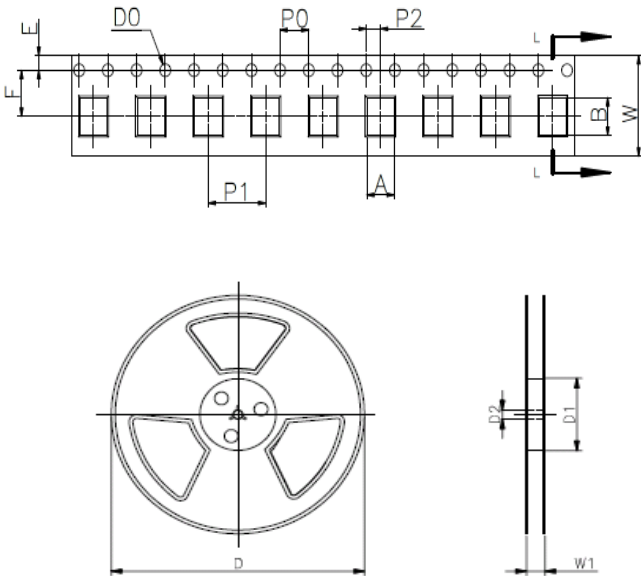

REF	mm	inch
A	2.4±0.1	0.094±0.004
B	3.2±0.1	0.130±0.004
D0	Φ1.5±0.2	Φ0.059±0.008
P0	4.0±0.2	0.157±0.008
P2	2.0±0.2	0.079±0.008
P1	4.0±0.2	0.156±0.008
E	1.75±0.2	0.069±0.008
F	5.5±0.2	0.217±0.008
W	12.0±0.2	0.472±0.008
D	Φ178±2	Φ7.008±0.079
D1	Φ58Min	Φ2.28Min
D2	Φ13±0.2	0.512±0.008
W1	16.8±0.2	0.496±0.008

Outline	Reel (PCS)	Per Carton (PCS)	Reel Diameter (mm)	Carton Size(mm)		
				L	W	H
TAPING	2,000	60,000	178	390	370	220